

Installation Guidelines

VBC Products



INSTALLATION GUIDELINES

Composite Vapor Barrier

STEP 1A: Ground Surface Preparation—Earth Base

Select the suitable Barrier-Bac Composite product (VBC-350, 31 mil) and ensure the installation surface is relatively smooth. Barrier-Bac should be unrolled to completely cover the pour area. When install Barrier-Bac Composite Vapor Barrier, the geotextile has to be placed facing up.

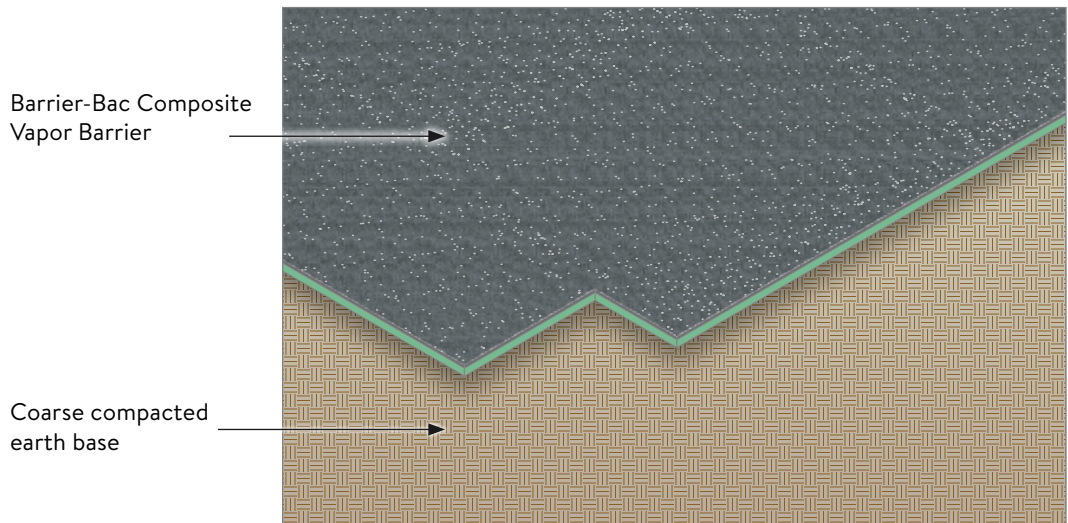

STEP 1B: Ground Surface Preparation—Aggregate Base

Although Barrier-Bac products are extremely tough, installation is easier and more effective when done over a smooth base. It is optional to have a layer of granular fill under the Barrier-Bac. When install Barrier-Bac Composite Vapor Barrier, the geotextile has to be placed facing up.

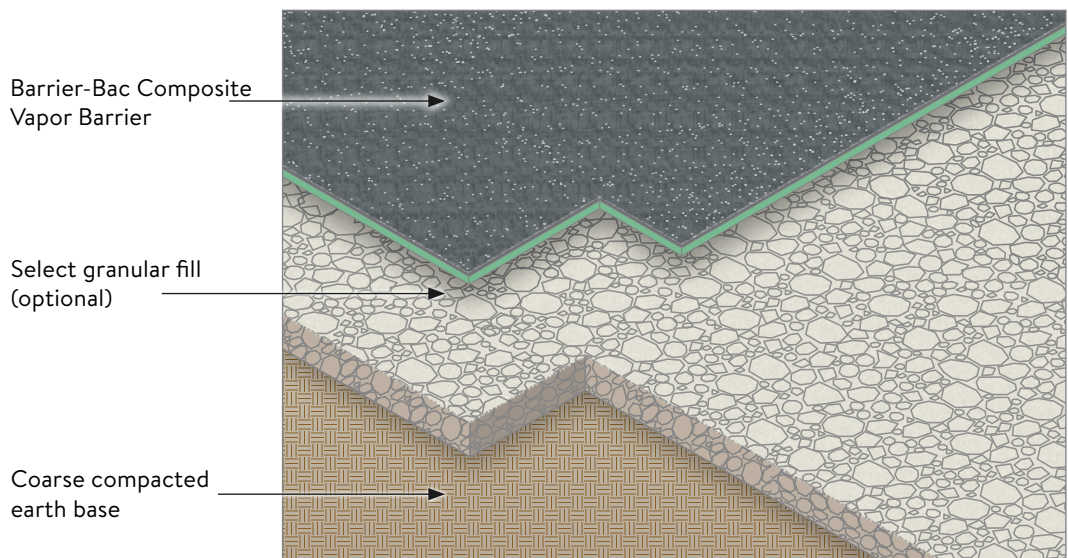

STEP 2: Unroll, Overlap And Tape The Seam

Please place the geo-textile (black color) side facing up. Seams and/or joints can be joined using Barrier-Bac Double-Sided Termination Tape. Two VBC-350 sheets should be overlapped six inches side-to-side and end-to-end.

Using Double-Sided Termination Tape to seal seams provides VBC-350 with 100% peel adhesion strength against concrete.

Note: In case project design specifications require or it is needed to use additional adhesive to secure Barrier-Bac Seam Tape, we recommend using 3M™ Scotch-Weld™ HoldFast 70 Cylinder Spray Adhesive Clear to apply on the geo-textile surface overlap prior to tape application.

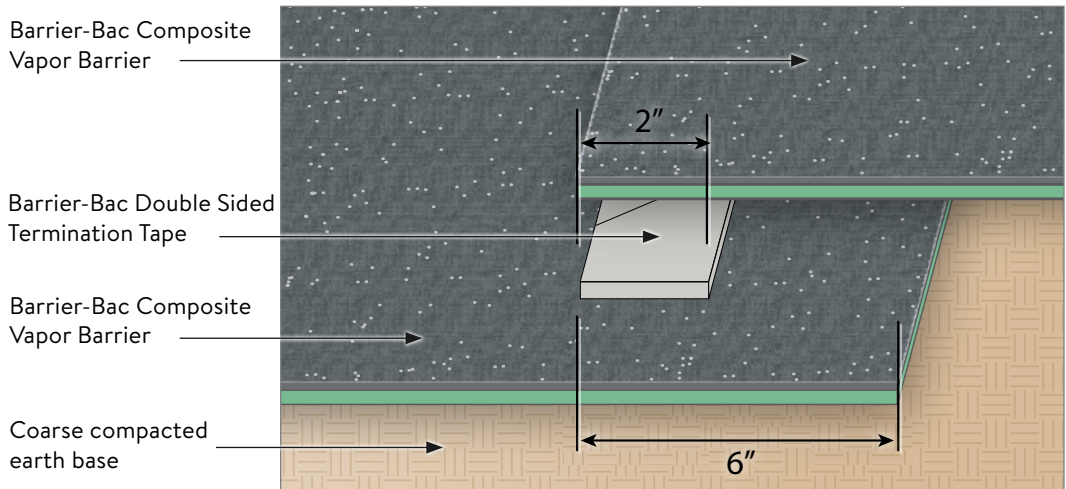

STEP 3: Pour The Concrete

Inspect all seams, penetration and damaged areas and make sure they are well sealed or patched. (See Step 6-1, 6-2 & 7: Seal Penetrations and Step 8: Patch Damage) After seal all penetrations and patch all damaged areas, pour the concrete on top of Barrier-Bac Composite Vapor Barrier.

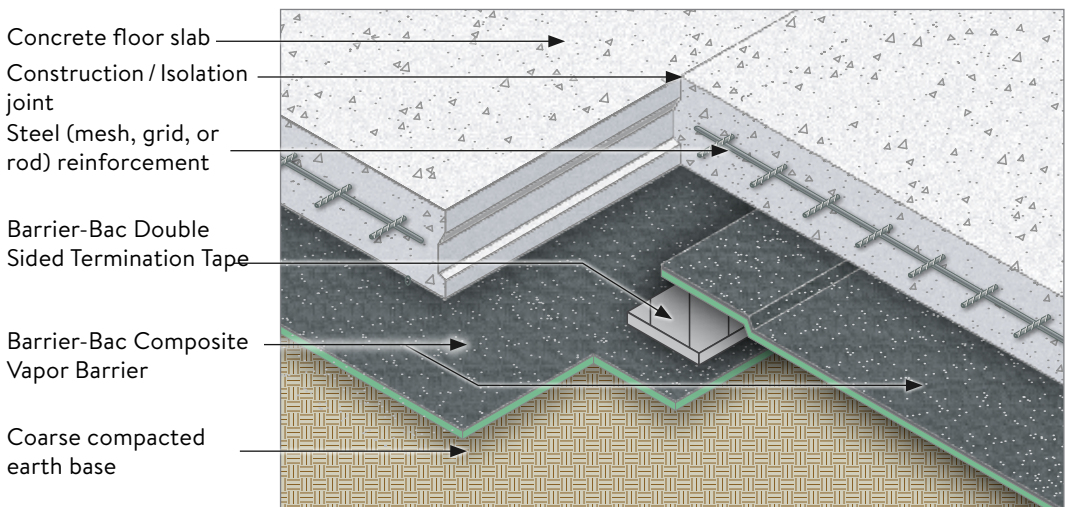

STEP 4: Pipe Penetration Details

See the details about making pipe boots at Step 6-1, 6-2: Seal Penetrations. For square penetrations, see Step 8: Square Penetrations

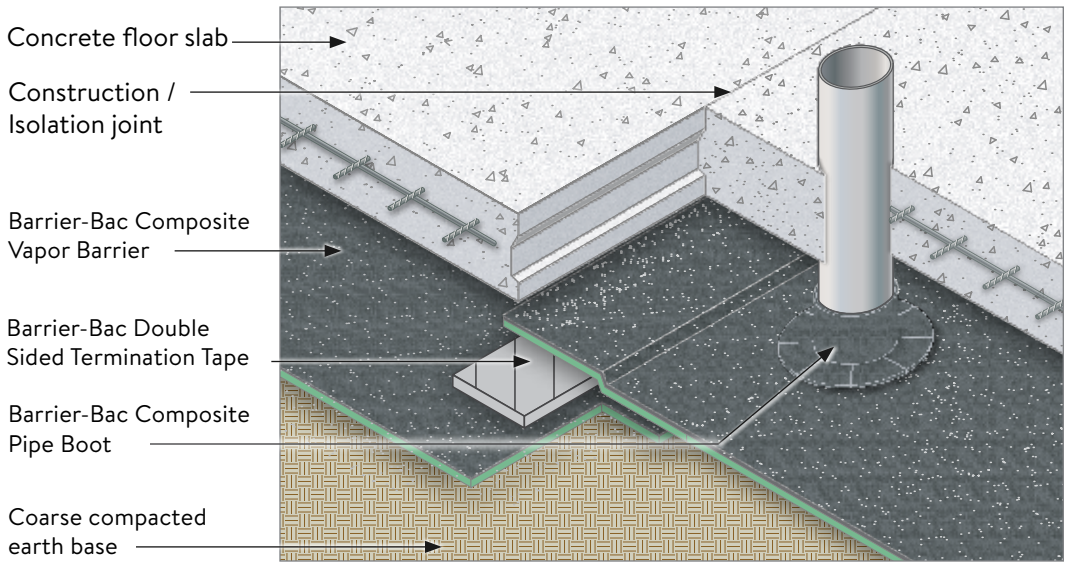

STEP 5: On Top of The Footing

When vertical wall is involved, please place the membrane butt end on top of the footing and up against the vertical wall. This placement method will provide the needed protection from outside moisture following construction completion.

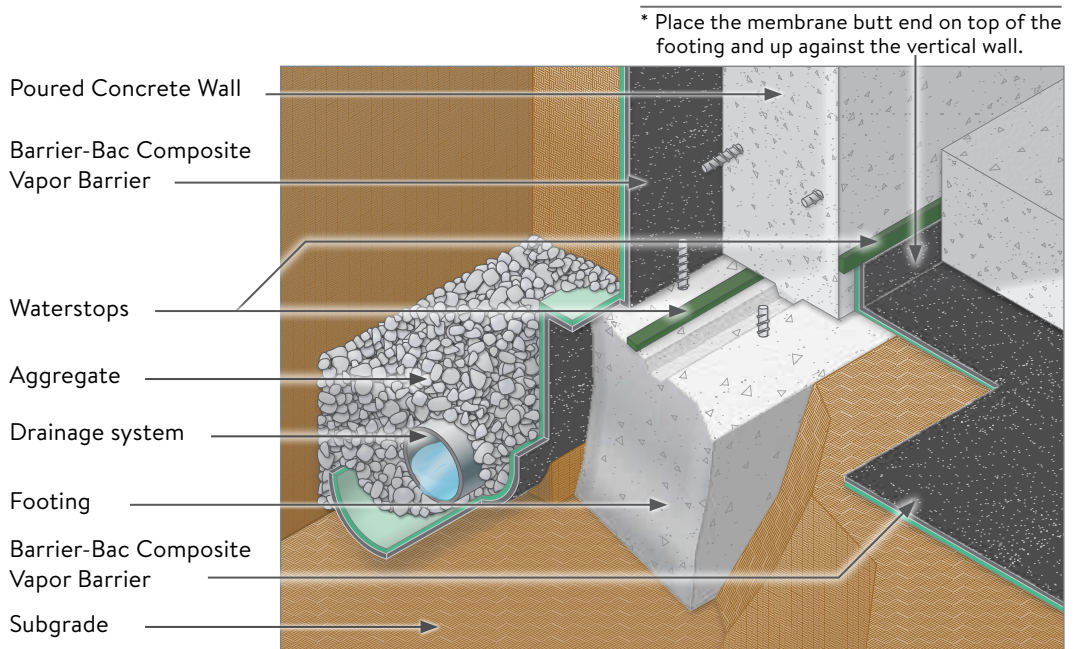

INSTALLATION GUIDELINES

STEP 6-1: Seal Penetrations—Round Penetrations With Pipe Boot (Option 1)

All penetrations must be sealed with the Barrier-Bac White Bond Tape.

- 1** Cut a circle in the Barrier-Bac at approximately the same size as the pipe diameter.

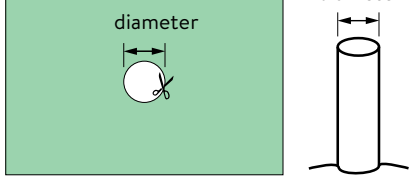
- 2** Install the Barrier-Bac film through the pipe.

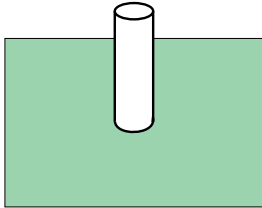
- 3** Cut an X in the center of a square piece of Barrier Bac. Each cut must be approximately the same length as the outside diameter of the pipe.

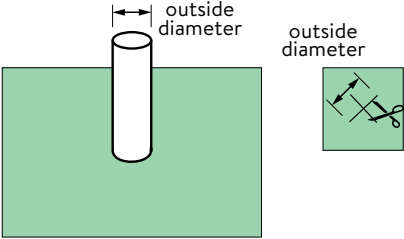
- 4** Push the patch to the bottom of the penetration.

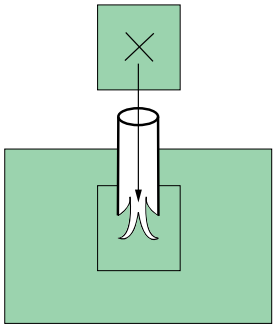

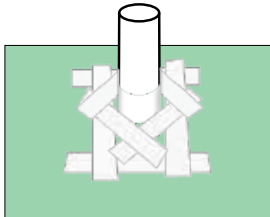
- 5** Secure all patch seams with Barrier-Bac White Bond Tape.



STEP 6-2: Seal Penetrations—Round Penetrations With Pipe Boot (Option 2)

All penetrations must be sealed with the Barrier-Bac Composite Vapor Barrier and White Bond Tape.

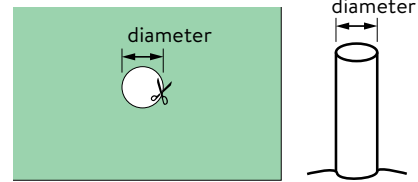
1 Cut a circle in the Barrier-Bac at approximately the same size as the pipe diameter.



2 Install the Barrier-Bac film through the pipe.

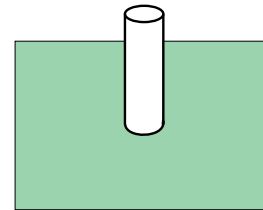

3 Measure a piece of Barrier-Bac Composite Vapor Barrier membrane 18 inches in width and twice (two times) the circumference of the pipe.

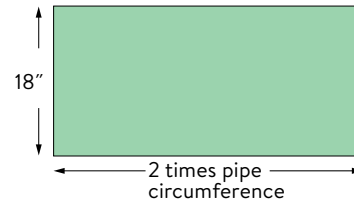

4 Roll the measured piece of membrane in a roll form approximately the size of pipe.

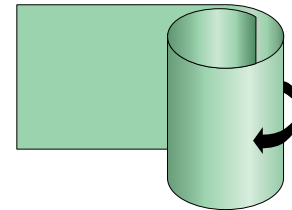

5 Flatten sized roll and make vertical cuts to approximately one-third of the width and two inches apart.

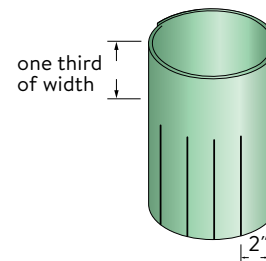

6 Open boot and wrap snugly around pipe, spreading cuts around base so strips lay horizontal to base. Tape around pipe circumference at top of boot, down side seam of boot and all two inch horizontal strips. Cover all seams of membrane with White Bond tape.

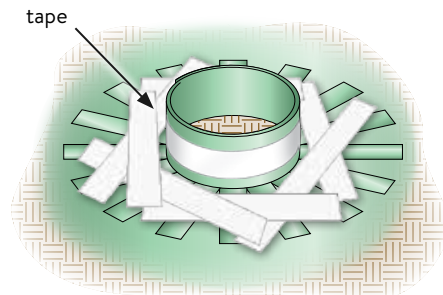

STEP 7: Seal Penetrations—Square Penetrations With Block Out

All penetrations must be sealed with the Barrier-Bac Composite Vapor Barrier and White Bond Tape. For square post

1

Cut a piece of Barrier-Bac Composite Vapor Barrier twice the height and one and one-half the length of the perimeter of the Block Out. Wrap membrane around Block Out and temporarily tape vertical seam.

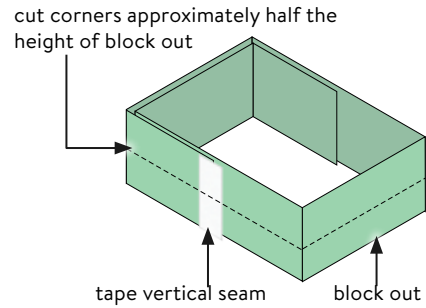

2

Make cuts in each of the four corners approximately half the height of the Block Out. Remove formed Block Out membrane form, flip over and replace on Block Out spreading flaps to horizontal position. Tape all flaps securely with Barrier-Bac White Bond Tape.

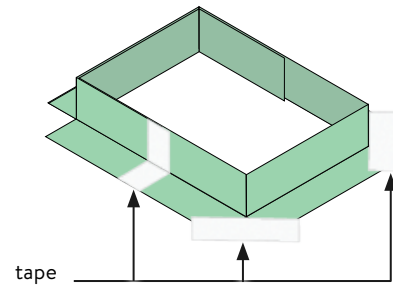

STEP 8: Patch Damages

All damages to the film must be sealed prior to pouring. Patch all damaged areas with Barrier-Bac Composite Vapor Barrier and White Bond Tape.

1

Cut a piece of Barrier-Bac Composite Vapor Retarder in a square large enough so sides of patch extend eight inches from side of puncture.

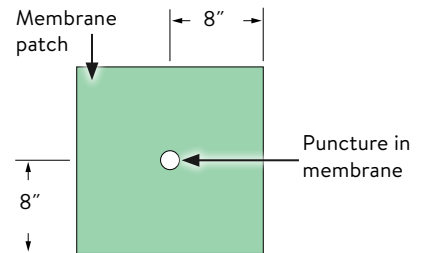

2

Cover damaged portion with membrane patch and secure all patch seams with Barrier-Bac White Bond Tape.

